

M60EN158

1/2

NOVA U,O,A,H

Surinkimo schema
Схема сборки
Assembling scheme

Reikalingi įrankiai:

Инструменты для сборки:

Requiring tools:



DIN911

x16

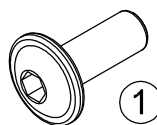

1

x6

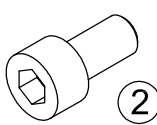

2

x2

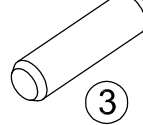

3

DNA* BNA*
CNN* CNM*

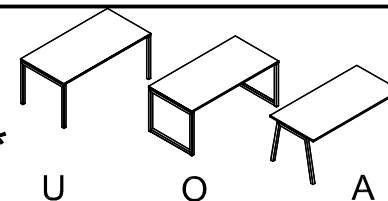

1

Neužveržti iki galo
Не затянуть до конца
Don't tighten to end

2

Užveržti visus varžtus
Затянуть все болты
Tighten up all screws

3

4

5.1

5.2

Stipriai užveržti
Крепко закрутить
Firmly tighten

H 62-85cm

H 62-85cm

! Neatsukite varžto
Не откручивай винт
Do not unscrew bolt all the way

NOVA SLIDE

Surinkimo schema
Схема сборки
Assembling scheme

Reikalingi įrankiai:

S5

Инструменты для сборки:

Requiring tools:

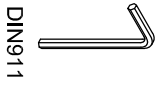

DIN911

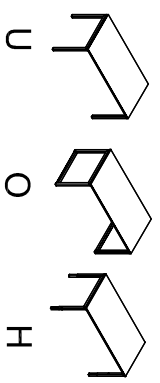
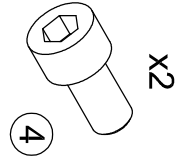
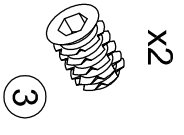
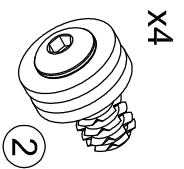
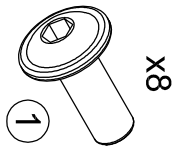

1

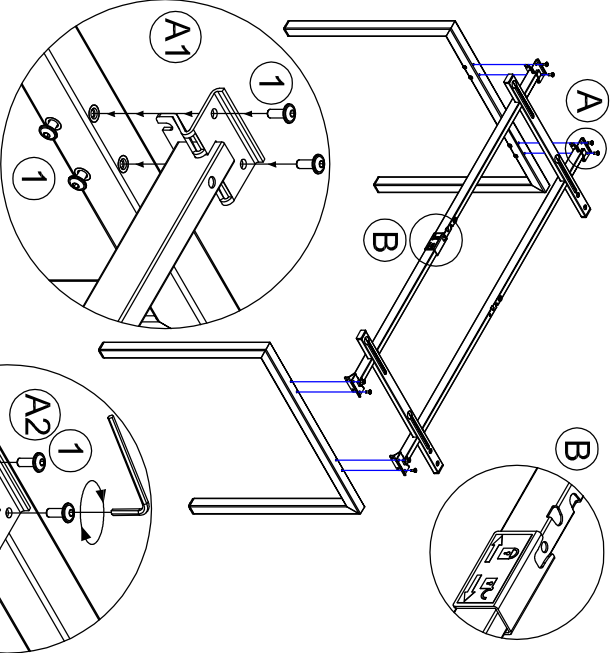

Neužveržti iki galo
Не затягивать до конца
Don't tighten to end

2

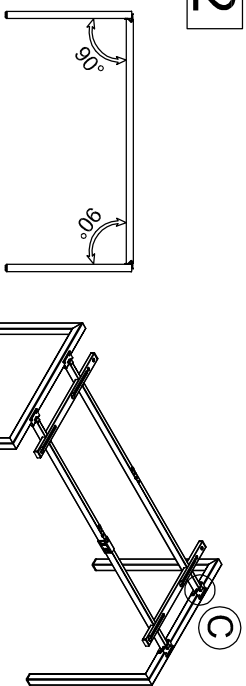

Užveržti visus varžtus
Затянуть все болты
Tighten up all screws

3

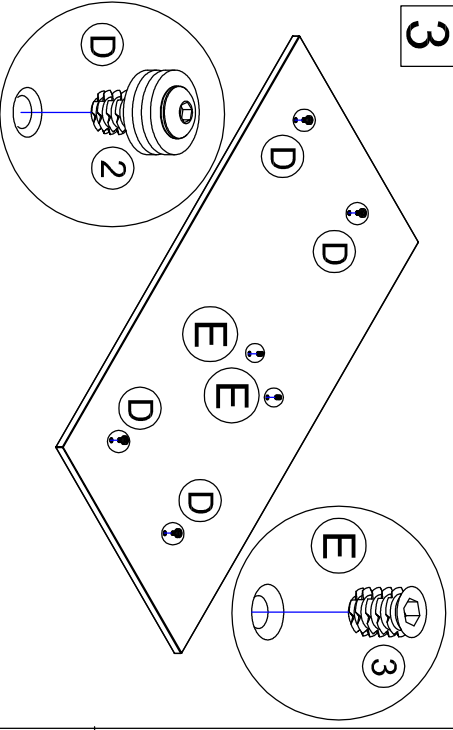

4

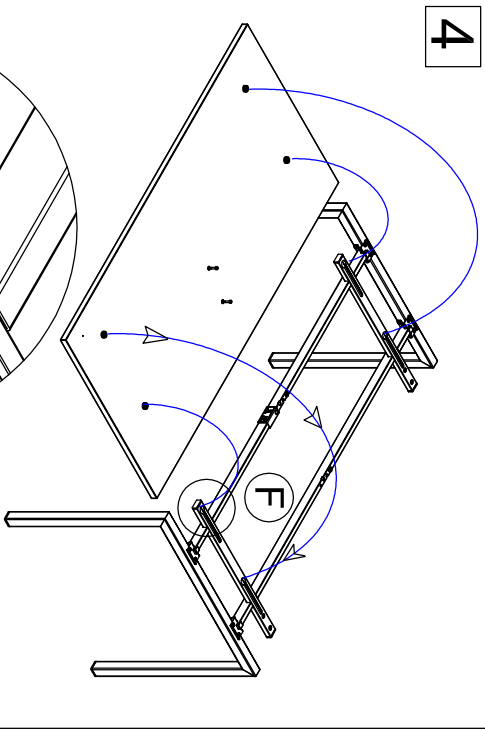

5

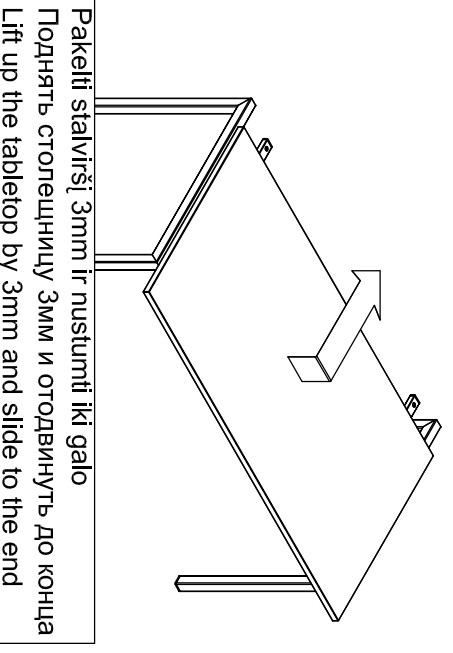

Pakelti stalviršį 3mm ir nustumti iki galo
Поднять столешницу 3мм и отодвинуть до конца
Lift up the tabletop by 3mm and slide to the end

6

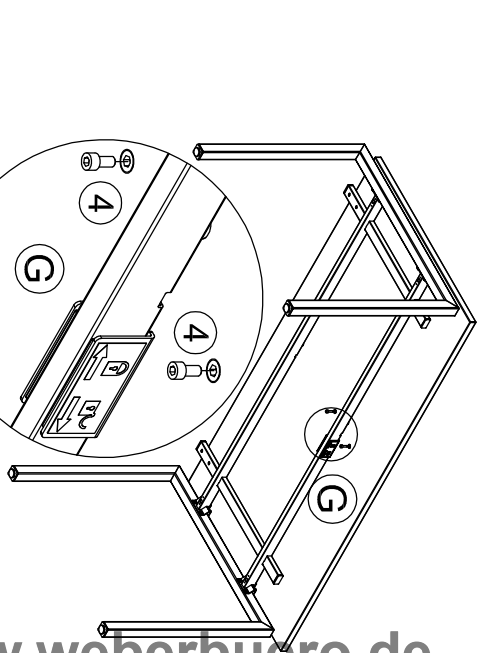

7

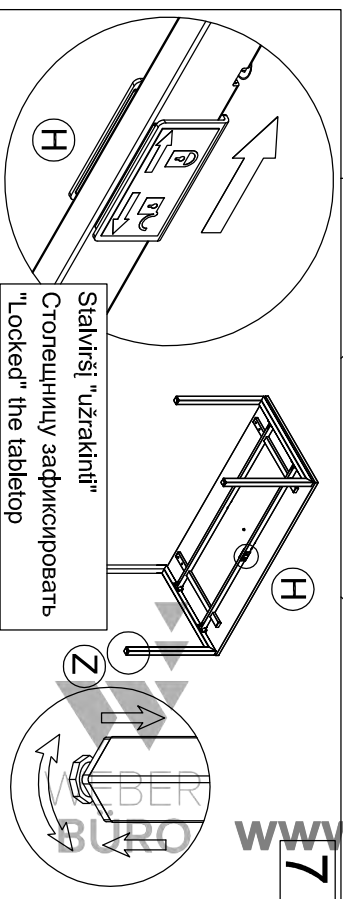

Stalviršį "užrakinti"
Столешницу зафиксировать
"Locked" the tabletop